

Facsimile with Cordless Phone

Quick Reference Guide

Model No. **KX-PW100CL**



Thank you for purchasing a Panasonic facsimile.

Table of Contents

Finding the controls	2
Installations and connections	4
Setting the date and time	8
Setting your facsimile telephone number	8
Setting your logo	9
Character input and command key table	10
Automatic dialing on the main unit	11
Automatic dialing on the portable handset	12
Sending faxes	13
Receiving faxes	14
Operating the built-in answering device	16
Individual e-mail services	18
Specifications	Back cover

- This guide explains some basic features and operations, but not all of them. For further details, see the Japanese operating instructions.
- This product is designed for use in Japan.
Panasonic cannot provide service for this product if used outside Japan.
- Any details given in this guide are subject to change without notice.

Finding the controls

Main unit (control panel)

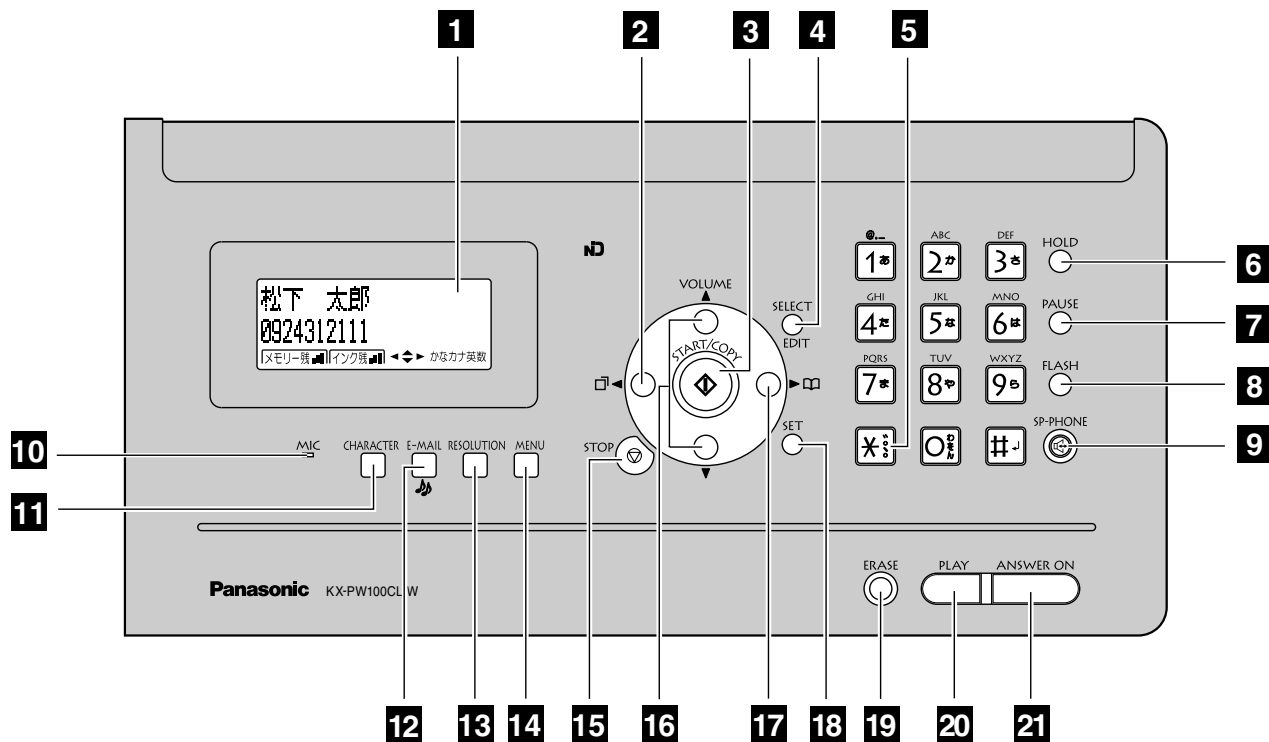







- 1** Liquid crystal display
- 2** Redial button
- 3** **Start/Copy** button starts faxing or copying.
- 4** **Select** button
Edit button
- 5** **Tone** button switches to tone dialing.
- 6** **Hold** button
- 7** **Pause** button
- 8** **Flash** button
- 9** **Speakerphone** button
- 10** **Microphone**
- 11** **Character** button
Mute button
- 12** **E-Mail** button
- 13** **Resolution** button selects the resolution when faxing or copying.
- 14** **Menu** button initiates programming.
- 15** **Stop** button
- 16** **Search** button searches the directory by pressing the up and down buttons.
Volume button adjusts ringer and speaker volume by pressing the up and down buttons.
- 17** **Phonebook** button
- 18** **Set** button
- 19** **Erase** button
- 20** **Play** button plays back recorded messages.
- 21** **Answer on** button
—light on: answering device activated.
—light off: used as a regular telephone.



Finding the controls

Portable handset

How to use key

-  To use the phonebook.
-  To redial the last number dialed.
-  To adjust the volume.
To change Hiragana into Kanji.

-  To make/answer calls.
-  To end a call.
To end or exit from editing or other operations.
- HOLD  To put a call on hold.
- ERASE  To clear letters/numbers.

- FLASH  For call waiting service users.
- FAX  To receive faxes.
- ALARM
- SP-PHONE  To use the speakerphone.



How to use function buttons

Function buttons refer to the function displayed on the bottom of the display. They function differently depending on the mode.

LCD (with back light)

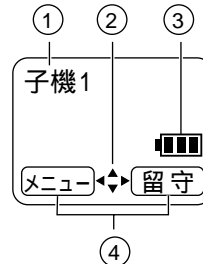
Displays battery strength, telephone numbers etc.





- ① Portable handset number
- ② Indicates which directions the  key can be tilted.
 -  up and down
 -  left
- ③ Battery strength
- ④ Function menu that is controlled by function buttons.

Charge indicator

When placed on a charger
 Charging Lights on
 Full Lights off

Dial buttons

-  Tone button
To switch to Tone dialing mode.
-  Sharp button

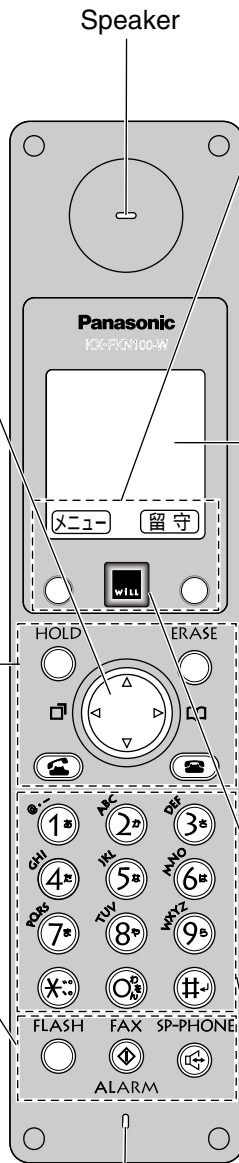

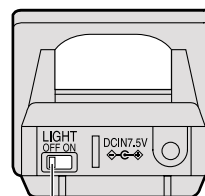
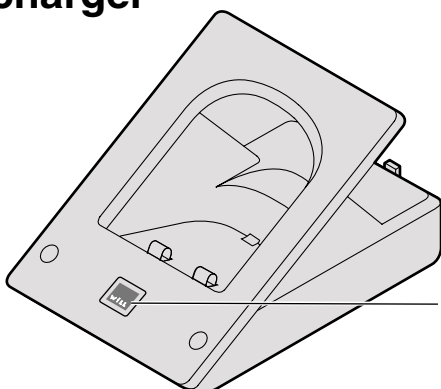

Microphone
 (Do not cover the microphone while talking.)

Battery charger



Switch

ON : The environs of  lights on
 OFF : The environs of  lights off

Installations and connections

Installing the ink film

- 1 Open the control panel.

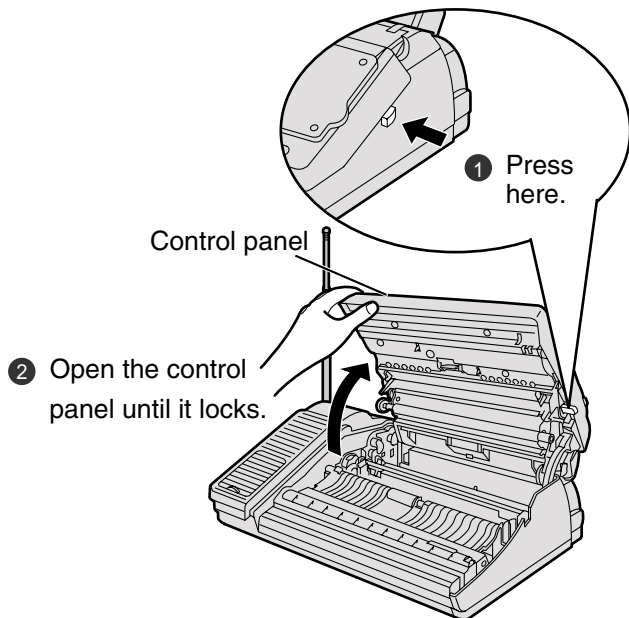

- 2 Insert the ink film.

- 1 Find the "T" shaped gear (blue).

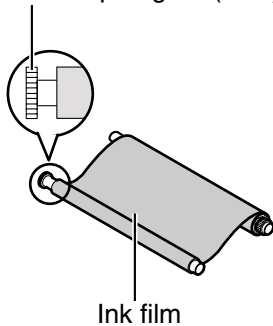

- 2 Insert the blue core into the right slot of the main unit.
- 3 Insert the "T" shaped gear (blue) into the left slot of the main unit.

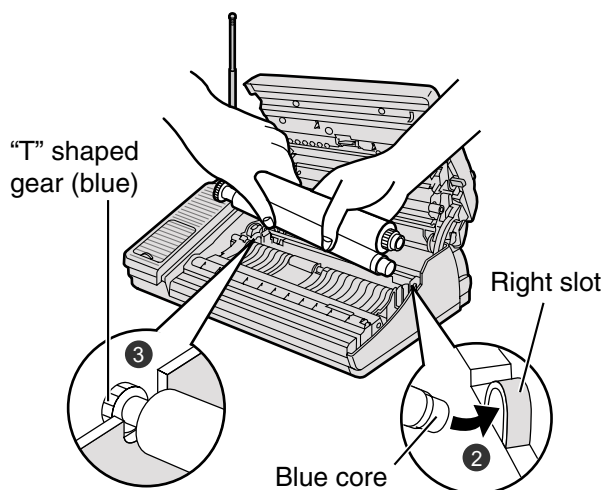

- 4 Insert the white core into the slots shown in the picture below.

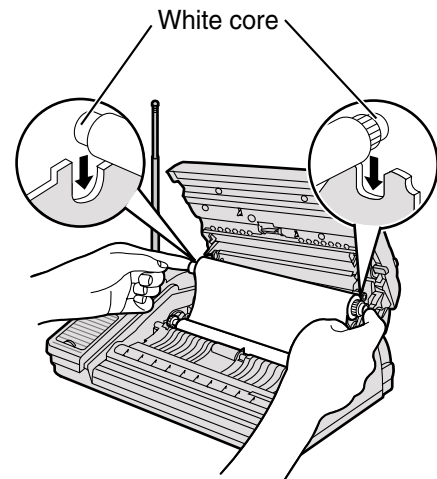

- 5 If the ink film is slack, tighten it by winding the "T" shaped gear.

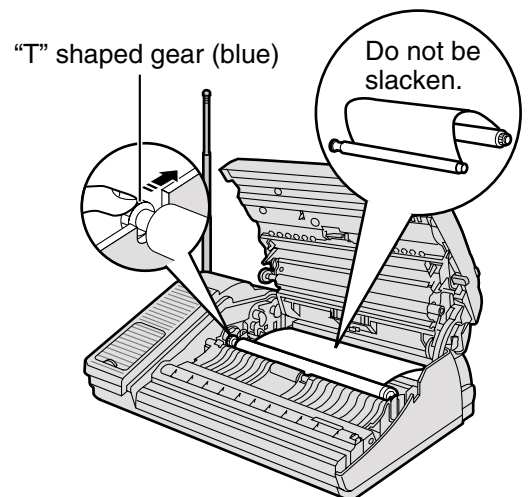

- 3 Close the control panel until it locks.

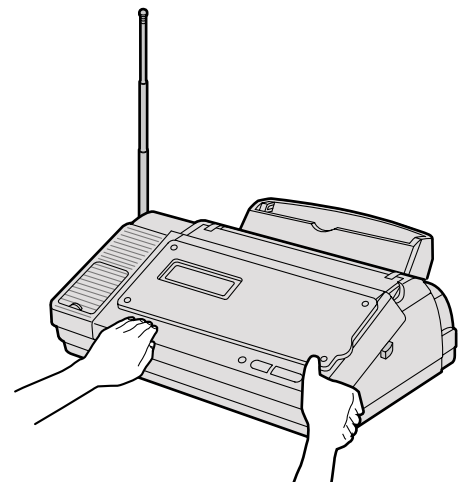

Installations and connections

Installing recording paper (A4 size)

1 Install the recording paper tray.

- 1 Insert the left tab on the recording paper tray into the left slot of the main unit.
- 2 Insert the right tab into the right slot of the main unit.

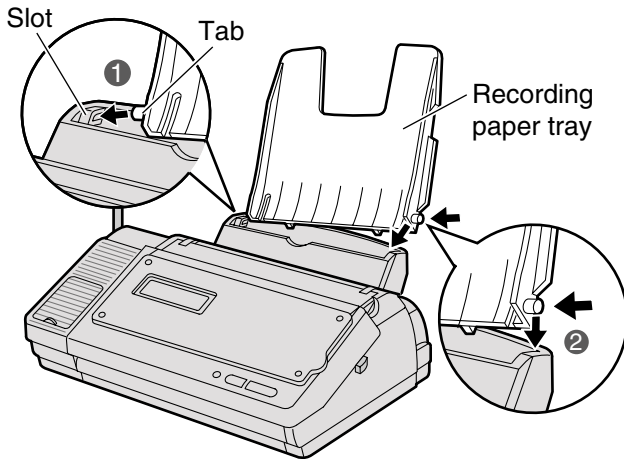

2 Insert the recording paper into the recording paper tray.

- 1 Open the paper entrance cover until it locks.

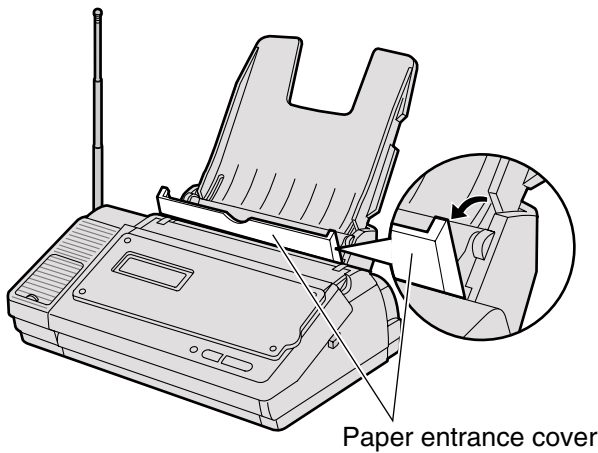

- 2 Fan the stack of recording paper (A4 size).
- 3 Insert the recording paper into the recording paper tray. (Up to 30 sheets)

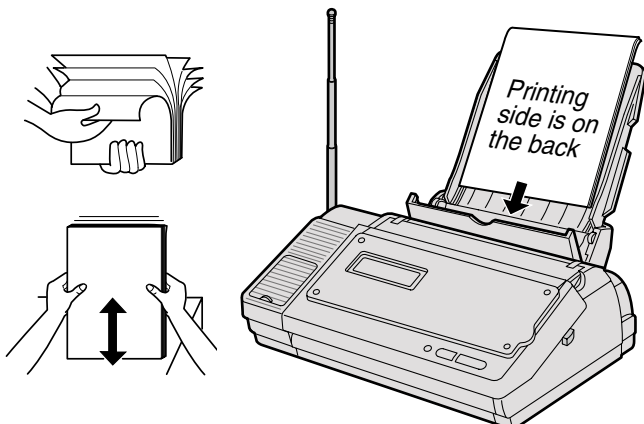

3 Close the paper entrance cover by leaning it back.

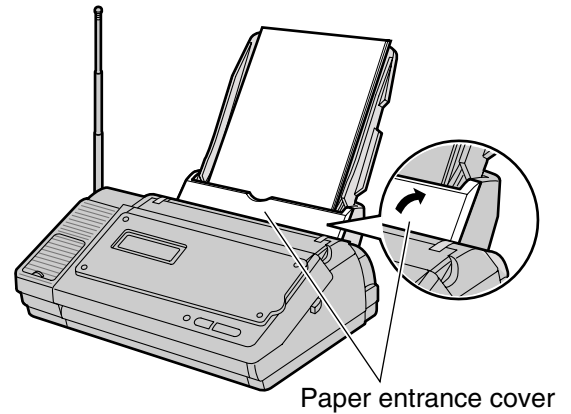

4 Install the recording paper cover on the recording paper tray by sliding it down from the top.

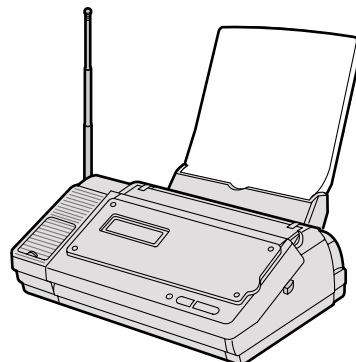
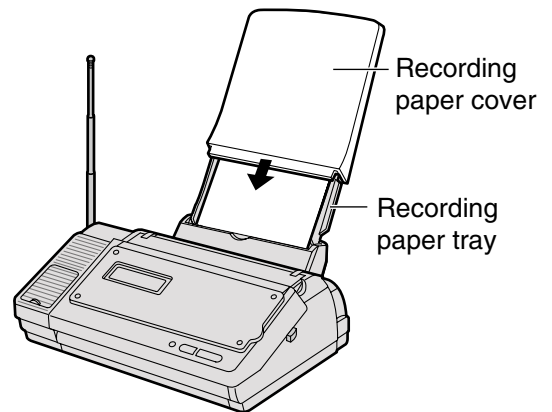

Installations and connections

Setting up the portable handset

1

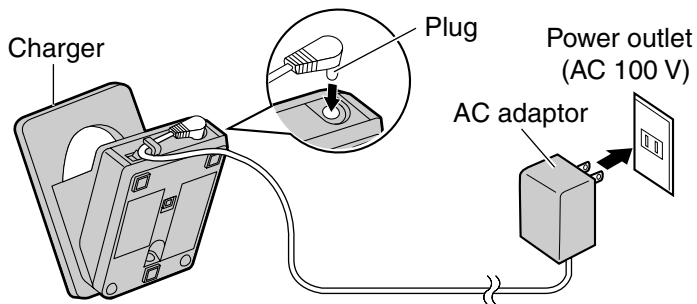

2

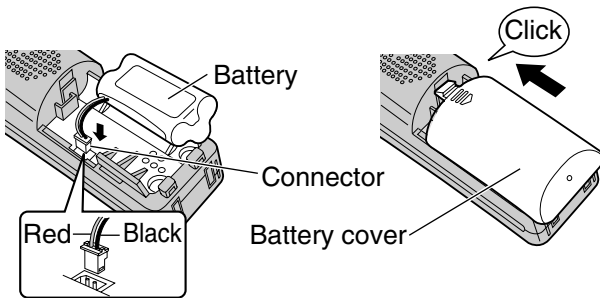

3 Charge the battery in the charger for 10 hours.

Charge indicator 
-lights on:
while charging.
-lights off:
charging completed.

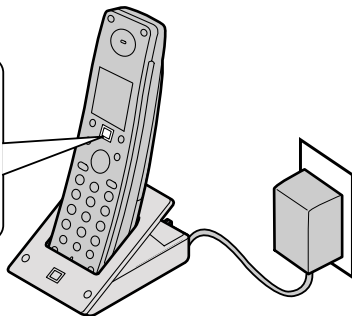

• After your Panasonic battery is fully charged, it will last up to about 7 hours of conversation.

• You can charge the battery in the main unit.

① Open the charger cover.

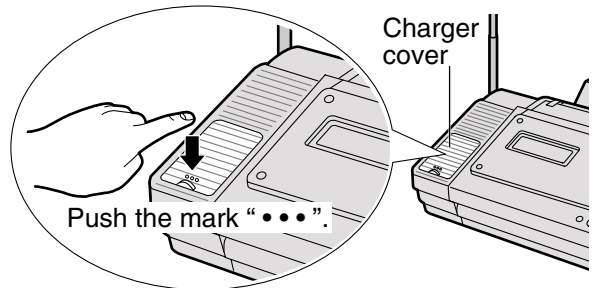

② Charge the battery for 10 hours.

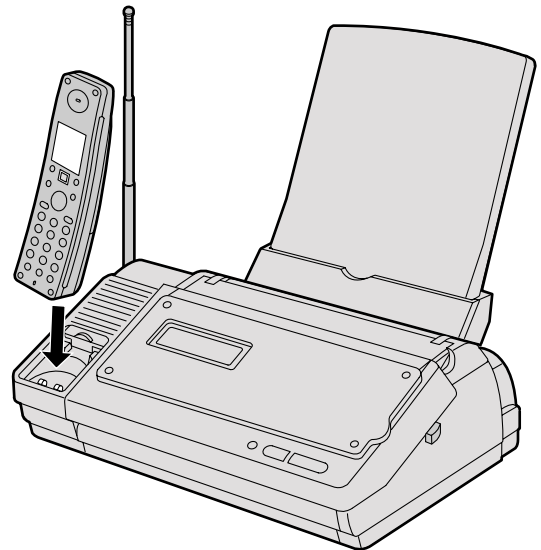

■ How to close the charger cover.

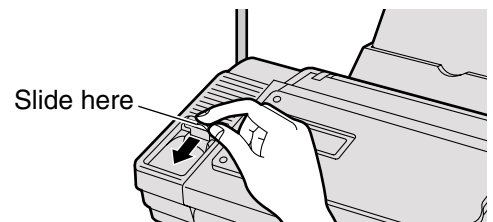

Installations and connections

Connecting the main unit

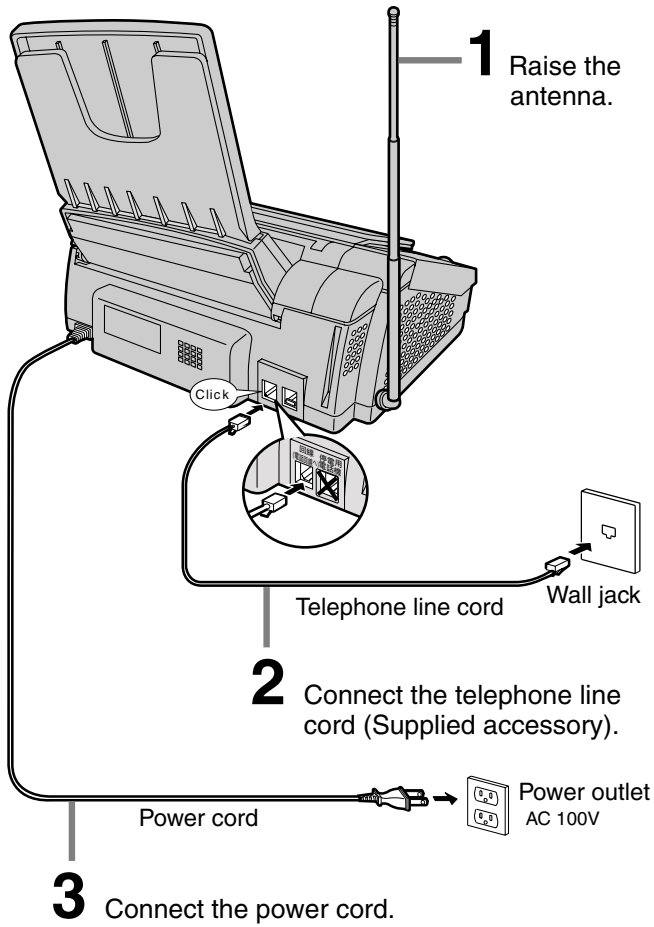

After the Power On...

This unit will automatically select the dialing mode (Tone/Pulse).

Setting the date and time

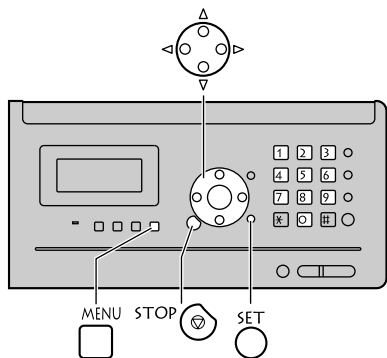

1 Press .

機能登録モード

2 Press (Search button) repeatedly until the following is displayed.

最初の設定 [SET]

3 Press .

Example :
 Cursor
 2002年 04月 01日
 10:10

4 Enter the correct year/month/day.

Example: May 1, 2002

Press .

2002年 05月 01日
 10:10

5 Enter the correct hour/minute in a 24-hour clock entry.

Example: 15:45 (3:45 PM)

Press .

2002年 05月 01日
 15:45

6 Press (Register).

登録しました



2002年 05月 01日
 15:45

7 Press .

Example :
 5月 1日 15:45
 用件録音 00件

Setting your facsimile telephone number

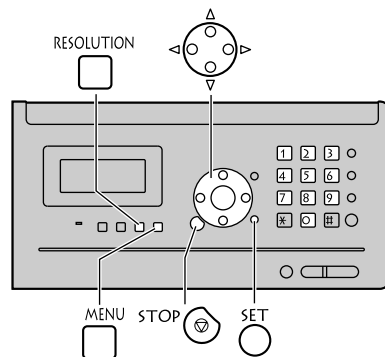

1 Press .

機能登録モード

2 Press (Search button) repeatedly until the following is displayed.

最初の設定 [SET]

3 Press .

Example :
 2002年 05月 01日
 15:45

4 Press (Search button) repeatedly until the following is displayed.

あなたの電話番号?
 TEL=

Cursor

5 Enter your facsimile telephone number, up to 20 digits.

Example: 098 765 43..

あなたの電話番号?
 TEL=98 765 43..

RESOLUTION
 The (Space) button replaces the digit with a space.

6 Press (Register).

登録しました



あなたの電話番号?
 TEL=098 765 43..

7 Press .

Example :
 5月 1日 15:45
 用件録音 00件

Setting your logo

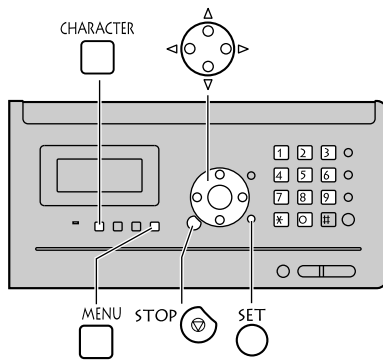

1 Press .

機能登録モード

2 Press (Search button) repeatedly until the following is displayed.

最初の設定 [SET]

3 Press .

4 Press (Search button) repeatedly until the following is displayed.

名前(プリント用)?
> Cursor

5 Enter your logo, up to 30 characters, using the dial keypad.

- To enter English characters easily, press (Character input mode) repeatedly and select “英” (English and sign input mode).
- For details, see the table on page 10 for instructions.

Example: Micah

1. Press once.

M
Cursor

2. Press six times.

Mi

3. Press six times.

Mic

4. Press to move the cursor to the next space and press four times.

Mica

5. Press five times.

Micah

6 Press (Register).

登録しました



Micah
> _

7 Press .

Character input and command key table

Character Dial key	Pressing the dial keys will select a character as shown below.			
	“かな” Hiragana	“カナ” Katakana	“英” English	“数” Numbers
1 ①	あいうえおあいうえお	アイウエオアイウエオ	@ . _ - & \$ ¥ % + = ^	1
2 ②	かきくけこ	カキクケコ	A B C a b c	2
3 ③	さしすせそ	サシスセソ	D E F d e f	3
4 ④	たちつてとっ	タチツテトツ	G H I g h i	4
5 ⑤	なにぬねの	ナニヌネノ	J K L j k l	5
6 ⑥	はひふへほ	ハヒフヘホ	M N O m n o	6
7 ⑦	まみむめも	マミムメモ	P Q R S p q r s	7
8 ⑧	やゆよやゆよ	ヤユヨヤユヨ	T U V t u v	8
9 ⑨	らりるれろ	ラリルレロ	W X Y Z w x y z	9
0 ⑩	わをんー！？()	ワヲンー！？()	! ? / - * # , ; : . ' ” () [] { } 「 」	0
* ⑪	“ ° 、 。		、 。	
Command keys	CHARACTER □ (Main unit), ○ (Portable handset)		Used to change the character input mode.	
	◀▶ (Main unit), ◀▶ (Portable handset)		Used to move the cursor to the left and right.	
	ERASE ○ (Main unit, Portable handset)		Used to delete a character.	
	RESOLUTION □ (Main unit), ○ (Portable handset)		Used to insert a space.	

- When entering e-mail address, the small letters are displayed before the capital letters.
- When entering e-mail address, you can not enter the following symbols: ` ° - . 「 」`
- When entering e-mail address, you can enter only English and Numbers.
- When entering e-mail message, pressing # (#) enables you to begin the new line. (“↵” is displayed.)
- The display items of the main unit are somewhat different from that of the portable handset.

Automatic dialing on the main unit

Storing names and telephone numbers in the phonebook

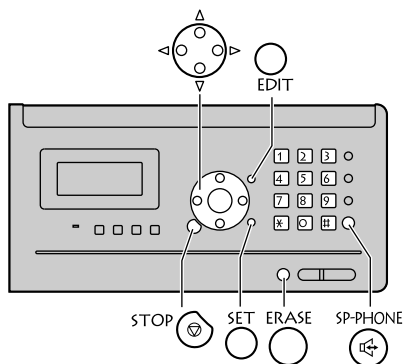

1 Press (Phonebook).

電話帳検索
登録は[SET]

2 Press (Register).

- “XXX” shows the remaining station numbers you can store.
- You can program up to 150 stations, including 4 pre-programmed stations.

電話帳空き x x x件



名前?
> _

3 Enter the name, up to 20 characters (see the table on page 10 for instructions).

4 Press (Register) twice.

5 Enter the telephone number, up to 30 digits.

- To correct a mistake, press .

6 Press (Register).

7 If necessary, enter the group number (1–9).

8 Press (Register).

- To program other items, repeat steps 3 to 8.

9 Press to exit the program.

Making a voice call using the phonebook

1 Press (Phonebook).

2 Press (Search button) repeatedly until the desired name is displayed.

3 Press (Speakerphone).

Editing a stored name or number

1 Press (Phonebook).

2 Press (Search button) repeatedly until the desired name is displayed.

3 Press .

4 Edit the name (see the table on page 10 for instructions), then press (Register).

- If you do not need to edit the name, press (Register) and skip to step 5.

5 Edit the kana (see the table on page 10 for instructions), then press (Register).

- If you do not need to edit the kana, press (Register) and skip to step 6.

6 Edit the telephone number, then press (Register).

- If you do not need to edit the telephone number, press (Register) and skip to step 7.

7 If necessary, enter the correct group number.

8 Press (Register).

Automatic dialing on the portable handset

Storing names and telephone numbers in the phonebook

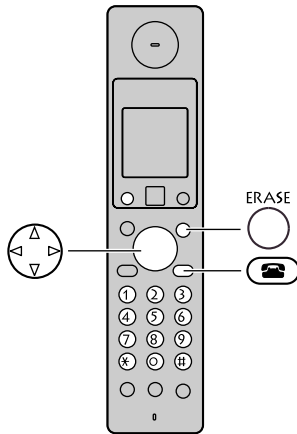

1 Press (Phonebook).

電話帳検索
名前？

2 Press (Register).

- “XXX” shows the remaining station numbers you can store.
- You can program up to 150 stations, including 4 pre-programmed stations.

名前？
空き x x x 件



名前？

3 Enter the name, up to 20 characters (see the table on page 10 for instructions).

4 Press (Register) twice.

5 Enter the telephone number, up to 30 digits.

- To correct a mistake, press .

6 Press (Register).

7 If necessary, enter the group number (1–9).

8 Press (Register).

- To program other items, repeat steps 3 to 8.

9 Press (Off) to exit the program.

Making a voice call using the phonebook

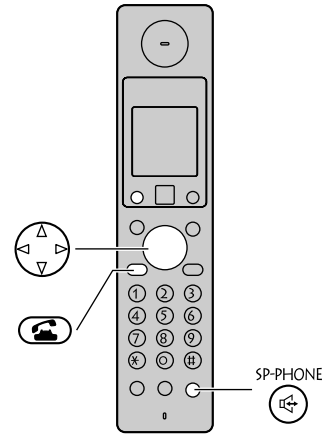

1 Press (Phonebook).

2 Press (Search button) repeatedly until the desired name is displayed.

3 Press (Talk) or press (Speakerphone).

Editing a stored name or number

1 Press (Phonebook).

2 Press (Search button) repeatedly until the desired name is displayed.

3 Press (Edit).

4 Edit the name (see the table on page 10 for instructions), then press (Register).

- If you do not need to edit the name, press (Register) and skip to step 5.

5 Edit the kana (see the table on page 10 for instructions), then press (Register).

- If you do not need to edit the kana, press (Register) and skip to step 6.

6 Edit the telephone number, then press (Register).

- If you do not need to edit the telephone number, press (Register) and skip to step 7.

7 If necessary, enter the correct group number.

8 Press (Register).

Sending faxes

Sending a fax manually

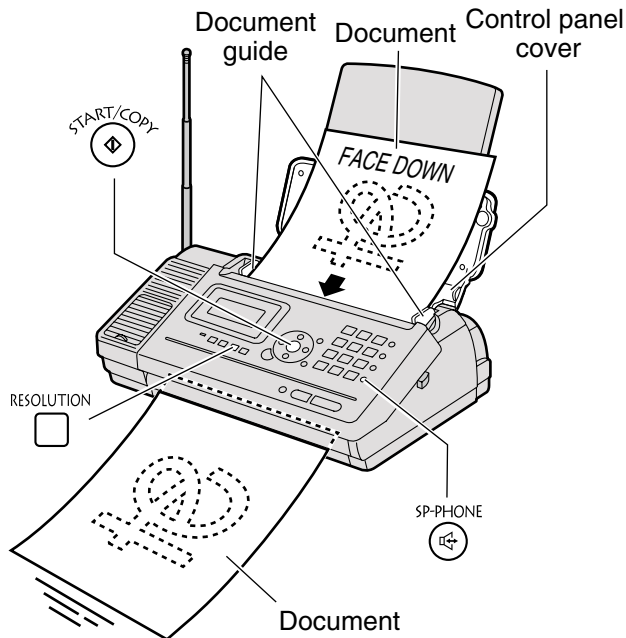

- 1 Open the control panel cover, and adjust the width of the document guides to the size of the document.
- 2 Insert the document (up to 5 pages) FACE DOWN until a single beep is heard.
- 3 If necessary, press repeatedly to select the desired setting (see below).
- 4 Press (Speakerphone).
- 5 Dial the fax number.
- 6 When a fax tone is heard, press (Fax).
 - The unit will start fax transmission.

Sending a fax using the phonebook

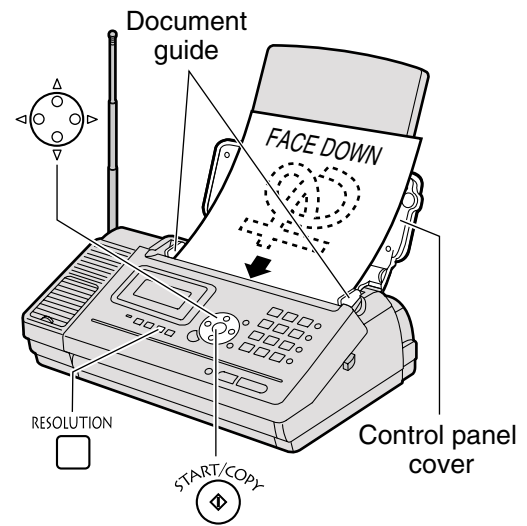

- 1 Open the control panel cover, and adjust the width of the document guides to the size of the document.
- 2 Insert the document (up to 5 pages) FACE DOWN until a single beep is heard.
- 3 If necessary, press repeatedly to select the desired setting (see below).
- 4 Press (Phonebook).
- 5 Press (Search button) until the desired name is displayed.
- 6 Press (Fax).
 - The unit will start fax transmission.

To select the resolution

Select the desired resolution according to the type of document, by pressing .

(Standard) for printed or typewritten originals with normal-sized characters.

(Fine) for originals with minute printing.

(Photo) for originals containing photographs.

Receiving faxes

Receiving a fax manually (AUTO ANSWER off)

Using the main unit:

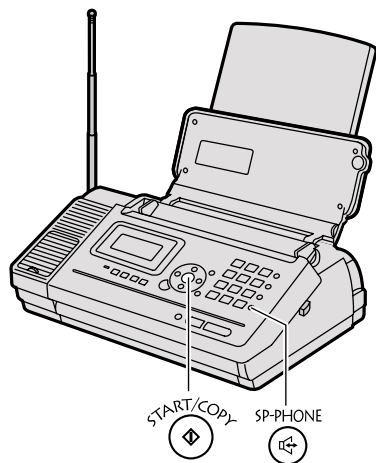

1 When you hear a ring, press  (Speakerphone) to answer the call.

2 When:
– document reception is required,
– a fax calling tone (slow beep) is heard, or
– no sound is heard,

press  (Fax).

- The unit will start fax reception.

Using the portable handset:

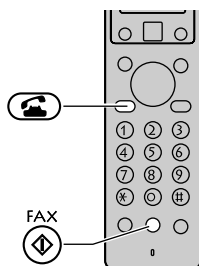

1 When you hear a ring, lift the portable handset from the charger to answer the call.

- If the portable handset is not set on the charger, press  (Talk).

2 When:
– document reception is required,
– a fax calling tone (slow beep) is heard, or
– no sound is heard,

press  (Fax reception).

- The main unit will start fax reception.

Receiving a fax automatically (AUTO ANSWER on)

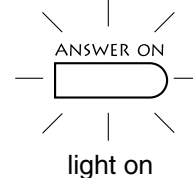
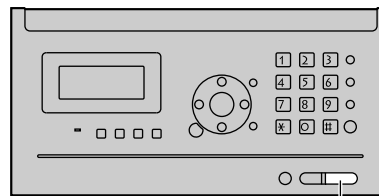

1 If the  light is off, turn it on by pressing



2 When receiving a call, the unit will receive a fax document or record a voice message automatically depending on the caller's request.

Receiving faxes

Recording your own greeting message

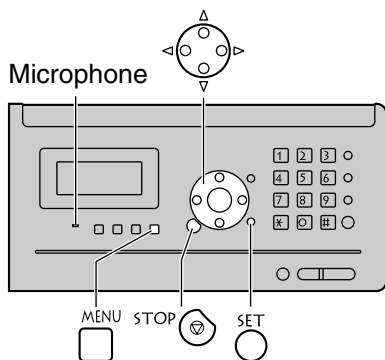

You can record your own greeting message. When receiving a call, it will be played to callers instead of the pre-recorded Japanese greeting message.

1 Press  .

2 Press  (Search button) repeatedly until the following is displayed.

留守番電話の設定
[SET]

3 Press  .

4 Press  (Search button) repeatedly until the following is displayed.

自作応答録音
[SET]

5 Press  .

6 Press  and record your greeting message, up to 16 seconds, to the microphone.

7 Press  .

- Your greeting message will be played back automatically.

Operating the built-in answering device

Activating the answering device

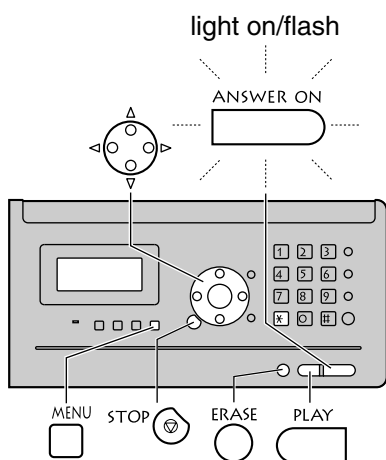

- 1 Turn the **ANSWER ON** light on by pressing **ANSWER ON**.
- 2 When receiving a call, a greeting message will be played and the unit will record a voice message.
 - To record your own greeting message, see page 15.

Listening to recorded messages

When new messages are recorded, the **ANSWER ON** light will flash.

Press **ANSWER ON** to listen to recorded messages. After the messages are played back, the following will be displayed.

再生した用件の消去は
[ERASE]を押す

- To erase the messages, push **ERASE**.
- To save the messages, push **STOP**.

Listening to all of the recorded messages

Press **PLAY**.

After the message are played back, the following will be displayed.

再生した用件の消去は
[ERASE]を押す

- To erase the messages, push **ERASE**.
- To save the messages, push **STOP**.

Erasing a specific message

Press **ERASE** while listening to the message you want to erase, then press **ERASE**.

Erasing all of the recorded messages

- 1 Press **ERASE** twice.

E r a s

- 1 Press **MENU**.

- 2 Press **SEARCH** (Search button) repeatedly until the following is displayed.

留守番電話の設定
[SET]

- 3 Press **SET**.

- 4 Press **SEARCH** (Search button) repeatedly until the following is displayed.

自作応答消去
[SET]

- 5 Press **SET**.



- 6 Press *****.

- The pre-recorded Japanese greeting message will be played when you receive a call.



Operating the built-in answering device

Operating the answering device from a remote location

Preparation: Programming the remote operation ID



1. Press  .
2. Press  (Search button) repeatedly until the following is displayed.

留守番電話の設定 [SET]

3. Press  .
4. Enter any 4-digit number (remote operation ID) except * or #.
5. Press  (Register).
6. Press  .

Operation: Listening to a recorded message from a remote location

Turn the  light on before you go out. Remote operations are available only from a touch tone telephone.

1. Call your unit.
2. Enter the remote operation ID during the greeting message.
3. Press  or wait 4 seconds.
 - Only the new recorded messages will be played back.
 - To listen to all the recorded messages, press  after the new messages have been played back.

Individual e-mail services

Using the e-mail services

Kyushu Matsushita Electric Co., Ltd. (hereafter called "KME") offers individual information services, such as e-mail.

Your fax machine with e-mail features will enable you to send an e-mail to another party's personal computer (PC) or another e-mail fax machine anywhere in the world through the Internet. Also, you will be able to receive an e-mail from them.

To access the Internet using your fax machine,

- you need a credit card (VISA, JCB or MASTER as of May 2002) and
- have to subscribe to individual information services offered by KME beforehand.

The application fee including call charges will be charged to your Credit Card.

Important:

- If your fax machine is connected to a home telephone system or a private branch exchange (PBX) system, these services are not available.

Application fee and call charges

KME information services	Registration fee	¥500
	Information Service fee (Call charge included)	¥20/minute (8 am-11 pm) ¥18.5/minute (11 pm-8 am)
	Melody download service "Yumekara" fee	¥50/a melody

- As of May 2002.
- Tax not included.

KME information services

The following services are available with your fax machine. The information service fee including the call charge will be applied.

- E-mail reception and printing (page 20)
- Voice e-mail listening (page 20)
- Text e-mail sending (page 21)
- Fax e-mail sending (page 21)
- Voice e-mail sending (page 22)
- Storing another party's e-mail address (free of charge) (page 23)
- Others

Note:

- KME plans to add new information services and the information service fee is subject to change. KME will announce them by e-mail to its customers.
- For the PC user to view your fax e-mail or to hear your voice e-mail sent from your fax machine, the following PC software will be required.
 - E-mail software that can read the MIME format
 - TIFF viewer software
 - WAV sound player software and sound system

Individual e-mail services

Subscribing to KME information services

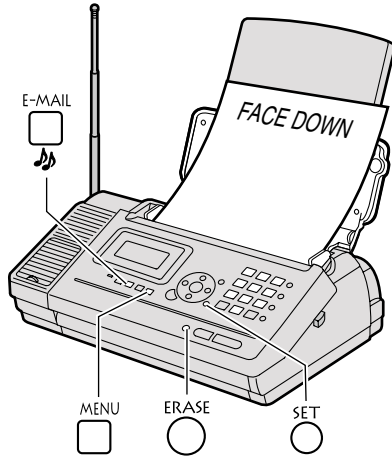

1 Fill in the included application form.

Your signature →
 Your name →
 Your address →
 Check your credit card type →
 Date of application →
 The telephone no. you wish to subscribe to KME →
 Your telephone no. for contact →

2 Press , then press .

3 Press .

クレジットカード No. ?
.....-.....-.....

4 Enter your 16-digit credit card number.

• To correct a mistake, press .

5 Press .

確認のため もう一度
.....-.....-.....

6 Enter your credit card number again, then press .

7 Enter the valid date of your credit card.

有効期限 ?
.. / .. (月 / 年)
Month Year

8 Press .

9 Insert the application form FACE DOWN.

10 Press .

• The unit will start fax transmission.

11 After approx. 5 minutes, the unit will ring, and a data communication will start automatically between your unit and KME.

• When you answer this call, the unit will hang up the call and start the data communication automatically.

12 When the communication is completed, a user registration form will be printed.

Your e-mail address
Your security ID code

• Please save the address and ID code for future reference.

13 Press .

14 Press twice.

• An information service guide will be printed.

Individual e-mail services

Receiving and printing an e-mail

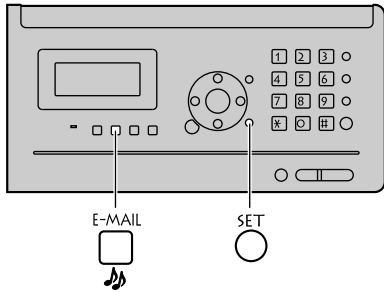

1 Press  , then press  .

2 Press  .

- If there is an e-mail you have not viewed yet, the unit will print the received e-mail.

- If there is no e-mail, the following will be displayed.

未受信 Eメール 0件

The file formats recognized by your fax machine are:

- JPEG • ~. doc
- TIFF • ~. xls
- BMP • ~. ppt
- TXT • ~. pdf
- WAV

(as of May 2002)

Listening to a received voice e-mail in an attached file

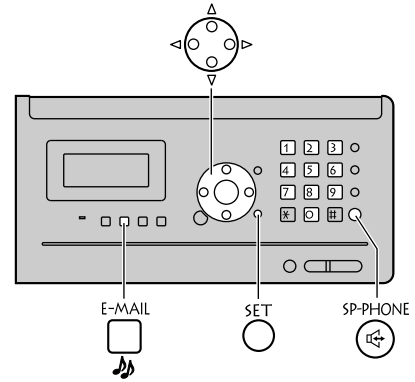

1 Press  , then press  .

2 Press  (Search button) repeatedly until the following is displayed.

音声 Eメール受信
[SET]

3 Press  .

4 Enter the document number with 4 digits.

- See the example below about the document number.

5 Press  .

6 Listen to an announcement through the speaker.

7 Listen to the voice message and operate following voice guidance.

8 Press  (Speakerphone) to finish listening.

Note:

- You can hear a voice in WAV format only.
- Voice data will be saved for 1 week in the server after the e-mail has been received.

Example of received e-mail document.

受信日時 : 2002/05/01 15:55 合計1ページ

 タイトル : 鳥の声
 送信日時 : 2002/05/01 15:52:04
 差出人 : taro@pana.co.jp
 宛先 : p1234 @fem.dion.ne.jp
 文書番号 : 0002 ← Document number

Individual e-mail services

Sending a text e-mail from the main unit

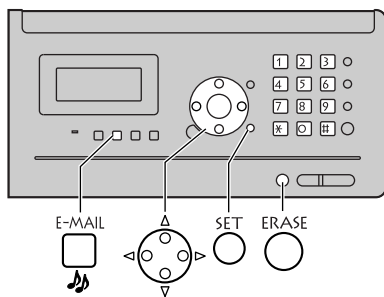

1 Press , then press .

2 Press (Search button) repeatedly until the following is displayed.

文字Eメール送信
[SET]

3 Press .

4 Enter the desired e-mail address (see the table on page 10 for instructions), then press .

- You can select the desired address using the search button.

1. Press (Phonebook), then press (Search button) repeatedly until the desired e-mail address is displayed.

2. Press , then press .

To store an address, see page 23.

5 Press .

- The display will show the last title you entered. To delete this title, press for 2 or more seconds.

6 Enter the title of your e-mail, up to 32 characters (see the table on page 10 for instructions).

7 Press .

- The display will show the last message you entered. To delete this message, press for 2 or more seconds.

8 Enter your e-mail message, up to 200 characters (see the table on page 10 for instructions).

9 Press .

Sending a fax e-mail

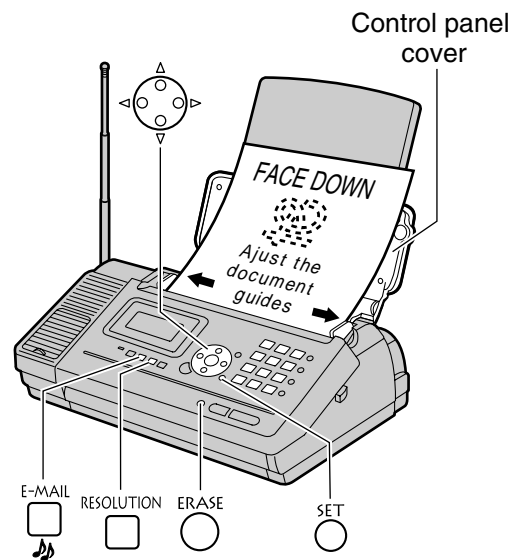

1 Open the control panel cover, and adjust the width of the document guides to the size of the document.

2 Insert the document (up to 5 pages) FACE DOWN until a single beep is heard.

3 If necessary, press repeatedly to select the desired setting (see page 13).

4 Press , then press .

5 Enter the desired e-mail address (see the table on page 10 for instructions) and press .

- You can select the desired address using the search button.

1. Press (Phonebook), then press (Search button) repeatedly until the desired e-mail address is displayed.

2. Press , then press .

To store an address, see page 23.

6 Press .

- The display will show the last title you entered. To delete this title, press for 2 or more seconds.

7 Enter the title of your fax e-mail, up to 32 characters (see the table on page 10 for instructions).

8 Press .

Sending a voice e-mail

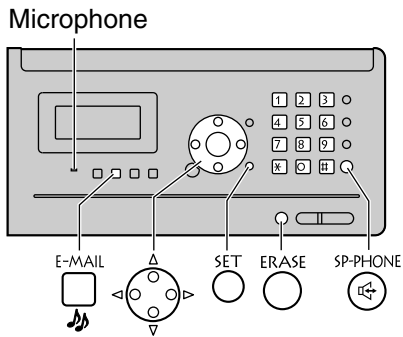

1 Press  , then press  .



2 Press  (Search button) repeatedly until the following is displayed.



音声Eメール送信
 [SET]

3 Press  .

4 Enter the desired e-mail address (see the table on page 10 for instructions) and press  .

- You can select the desired address using the search button.

1. Press  (Phonebook), then press  (Search button) repeatedly until the desired e-mail address is displayed.

2. Press  , then press  .

To store an address, see page 23.

5 Press  .

- The display will show the last title you entered. To delete this title, press  for 2 or more seconds.

6 Enter the title of your e-mail, up to 32 characters (see the table on page 10 for instructions).

7 Press  .

- An announcement about how to record will be heard.

8 Record your voice message up to 60 seconds, following voice guidance, using the microphone.

9 Press  (Speakerphone) to finish recording.

Individual e-mail services

Storing another party's e-mail address in the search button

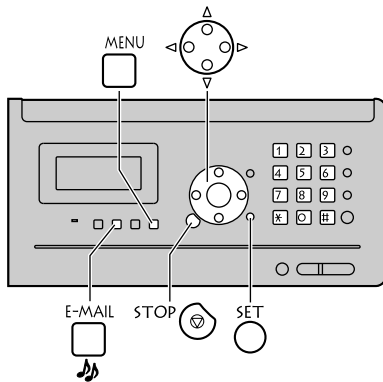

- 1 Press , then press .
- 2 Press (Search button) repeatedly until the following is displayed.

アト*レス帳	[SET]
--------	---------
- 3 Press .
- 4 Press (Register).
 - "XX" shows the remaining station numbers you can store.
 - You can store up to 30 stations.

アト*レス帳 空き xx件
↓
名前 ?
> _
- 5 Enter the name, up to 20 characters (see the table on page 10 for instructions).
- 6 Press (Register) twice.
- 7 Enter the e-mail address, up to 60 characters (see the table on page 10 for instructions).
- 8 Press (Register).
 - To program other items, repeat steps 5 to 8.
- 9 Press to exit the program.

Editing a stored e-mail address

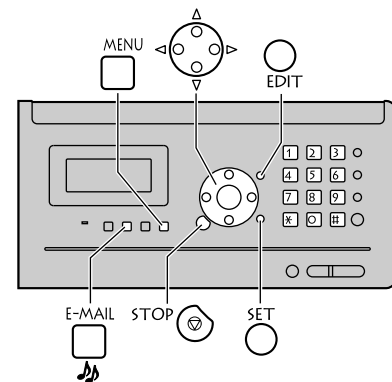

- 1 Press , then press .
- 2 Press (Search button) repeatedly until the following is displayed.

アト*レス帳	[SET]
--------	---------
- 3 Press .
- 4 Press (Search button) repeatedly until the desired name is displayed.
- 5 Press .
- 6 Edit the name (see the table on page 10 for instructions), then press (Register).
 - If you do not need to edit the name, press (Register) and skip to step 7.
- 7 Edit the kana (see the table on page 10 for instructions), then press (Register).
 - If you do not need to edit the kana, press (Register) and skip to step 8.
- 8 Edit the e-mail address (see the table on page 10 for instructions).
 - If you do not need to edit the e-mail address, skip to step 9.
- 9 Press (Register).
 - To edit other items, repeat steps 4 to 9.
- 10 Press to exit the editing.

Specifications

KX-PW100CL	Main unit	Portable handset	Battery charger
Power supply	AC 100 V (50 Hz/60 Hz)	Ni-MH battery (Part no. KX-FAN50) DC 3.6 V, 600 mAh	AC adaptor (Part no. PFAP1009) AC 100 V (50 Hz/60 Hz) DC 7.5 V, 100 mA
Power consumption	Transmission: Approx. 16 W Reception: Approx. 20 W Copy: Approx. 20 W Stand by: Approx. 1.4 W Maximum(*1): Approx. 125 W		<ul style="list-style-type: none"> • Charging: Approx. 1.5 W • Stand by: Approx. 0.4 W
Dimensions (H x W x D)	Approx. 139 X 358 X 253 mm (without projections and Portable handset) Approx. 378 X 358 X 253 mm (recording paper tray installed, without projections)	Approx. 186 X 43 X 39 mm	Approx. 65 X 69 X 91 mm
Mass (Weight)	Approx. 3.8 kg (10 m ink film installed, without portable handset)	Approx. 170 g (battery installed)	Approx. 70 g
Operating environment	5 °C – 35 °C, 45 % – 85 % RH (Relative Humidity)		

KX-PW100CL	Main unit
Applicable line	Public Switch Telephone Network (Tone/Pulse), F-Net, NCC Lines
DC resistance	320 Ω (*2)
Compatibility	G3 compatible
Document size	B4-A5(Max.257 mm in width, Max. 800 mm in length)
Effective scanning size	252 mm (B4) 208 mm (A4)
Effective printing size	202 mm (A4 size plain paper)
Transmission time	Approx. 15 s/page (Original mode) (*3)
Modem speed	9,600 / 7,200 / 4,800 / 2,400 bps; Automatic fallback
Halftone level	64-level
Scanning density	Horizontal: 8 pels/mm Vertical: 7.7 lines/mm (Fine/Photo), 3.85 lines/mm (Standard)
Scanner type	Contact image sensor
Printer type	Thermal transfer printing on plain paper
Data compression system	Modified Huffman (MH), Original mode
Recording paper size	A4: 210 mm x 297 mm (Plain paper)
Answering device	Greeting message: Digital recording system (up to 16 sec) Pre-recording greeting message ICM Recording: Digital recording system (Approx. 18 min. in total) (*4)
Memory capacity	Max. Approx. 46 pages (Only receiving fax etc.) (*5) Max. Approx. 18 min. (Only Recording message) (*4)

*1 When copying a 100% black document.

*2 If you cannot make a call due to DC resistance, consult your dealer.

*3 Transmission speed is based on an A4-size document of 700 characters sent in standard resolution at 9,600 bps. The actual transmission speed depends upon the contents of the page, resolution, telephone line conditions and capability of the other party's machine.

*4 If there is a silent pause, the total recording time will be longer.

*5 The memory capacity is based on an A4-size document of 700 characters.